

FT-ICR Mass Spectrometer
QUANTRA

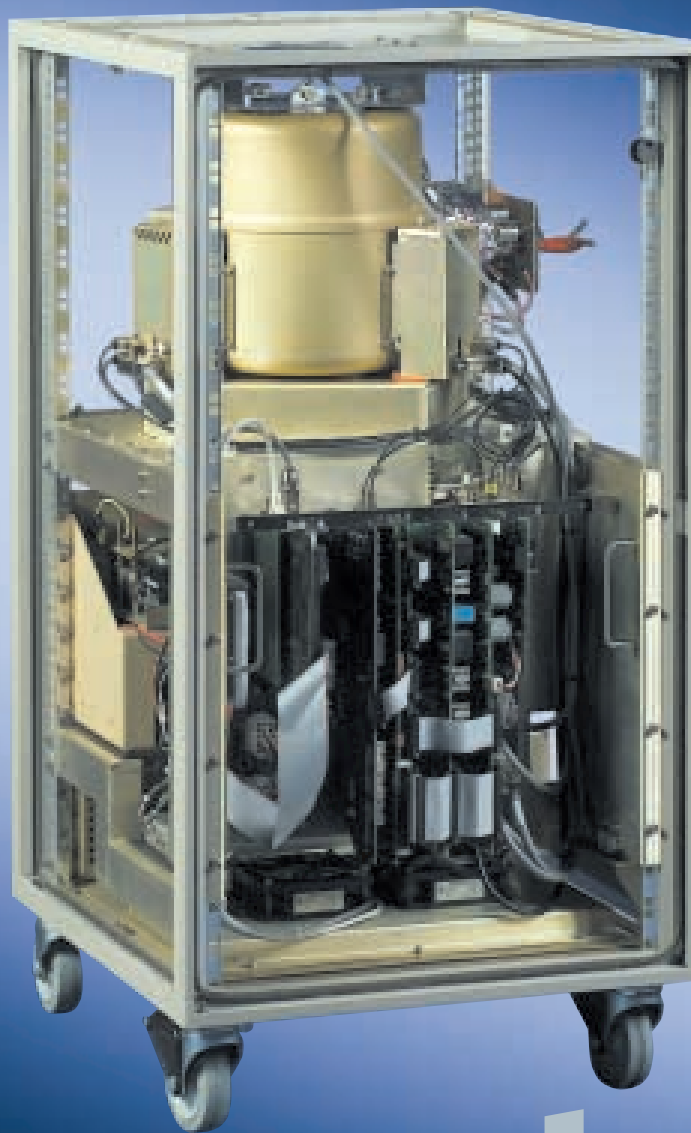

quantra

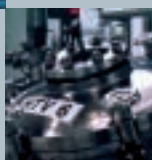

SIEMENS

QUANTRA – FT-ICR for the Masses

Siemens' long-term success in the design of high-quality gas chromatographic equipment is inherent in the design of its QUANTRA FT-ICR mass spectrometer. For many years mass spectrometers have been used in the world's top laboratories, but because of their very high cost and complexity they never gained full acceptance in small labs with small budgets. One type of mass spectrometer that is predominately found in the large laboratories is the Fourier Transform – Ion Cyclotron Resonance (FT-ICR) mass spectrometer. While FT-ICR mass spectrometers offer unparalleled mass resolution and accuracy, they have a high price tag... up to one million dollars for some models. That is until now. Any laboratory can now afford to purchase a Siemens QUANTRA FT-ICR mass spectrometer.

- FT-ICR Power at Affordable Price – QUANTRA brings the power of FT-ICR mass spectrometer.
- High Mass Accuracy – with a mass accuracy of 10 ppm (0.0004 @ 28 amu) the QUANTRA makes compound identification easier and more reliable.
- High Resolution – because of its mass resolution at 20,000 @ 100 amu common interferences that can affect most mass spectrometers are eliminated.
- Robust Design – having few moving parts and an ion pump with an MTBF that exceeds millions of hours, the QUANTRA is virtually maintenance-free.

Theory of Operation

An FT-ICR mass spectrometer is similar to other mass spectrometers; it ionizes a sample, separates the ions by their mass-to-charge ratio and then measures the presence and concentration of those ions. The difference between the FT-ICR and other mass spectrometers is how the measurement tasks are accomplished.

At the heart of the FT-ICR technique are two basic physical principles. The first principle is that a charged particle (ion) will rotate around the magnetic field line of a homogeneous magnetic field in a circular motion. This circular rotation (or cyclotron motion as it is called) provides a mechanism to "contain" a mixture of ions in a fixed space (Figure 1). Trapping plates are used to keep the ions from "spreading" out along the magnetic field line. Thus, this first principle allows ions to be contained in a fixed region. The next step is to find some way to discern what mass the ions are and in what amount.

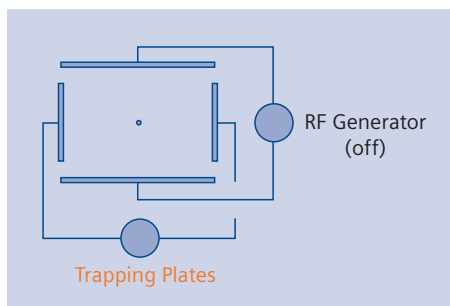

Figure 1: Trapping plates keep the ions in the centre of the cell

This is accomplished by the second basic physics principle. This principle is, that each unique ion mass will absorb or resonate with a very specific and unique resonance frequency (RF). So if we wanted to measure for the presence of a specific ion, like the N_2 ion for example, we could beam in the RF frequency that N_2 would absorb. As the N_2 ions absorb this energy, the orbit that the N_2 ions follow increases until it "leaves the pack" of the other ions in the mixture (Figure 2). The N_2 ions are still rotating on the same magnetic field line as the others, just in a higher orbit. Consequently, with appropriate variation of the RF frequencies, it is possible to measure a wide range of ion masses.

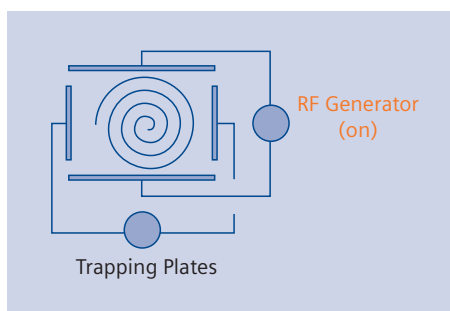

Figure 2: The RF frequency moves the ions into a higher orbit

Once the selected ions of the desired mass are in a higher orbit, they are measured using two “surface-image effect” detector plates. These plates work by sensing the movement of electrons from one plate to the others as the ions rotate in the cell. The electron movement results from the positively charged ions passing over a detector plate causing the electrons to move to that plate. On the other half of the ion’s circular rotation, the electrons will migrate to the other plate. This back and forth movement of electrons can then be measured as an indication of ion strength.

So if we take the two plates needed for trapping the ions, the two plates needed to generate the RF frequency, and the two plates needed for detection of the ions, we have the six sides of a cube that makes up a typical ICR measurement cell (Figure 3).

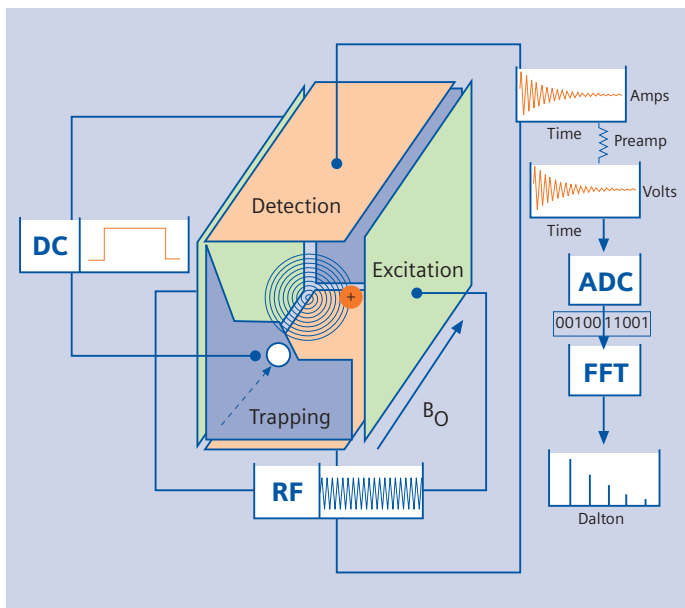

Figure 3: Measurement cell

The actual analysis itself works by first turning off the field trapping plates so that any resident ions are ejected. The trap plates are turned back on and the sample is injected. Once in the chamber, the sample is ionized. The RF plates then emit the appropriate signals to excite the ions of interest where they are measured by the detection plates. At the end of the analysis, the trapping plates are again turned off to allow the sample to flush out in preparation for the next analysis. The total analysis time for this sequence is measured in milliseconds.

In practice, measuring one ion mass at a time is too cumbersome and too “slow” so the actual implementation of these concepts in real ICR devices is to measure all ions simultaneously with a broad range “chirp” of RF frequencies. Fourier Transform (FT) mathematics then converts the time domain signals to frequency domain, which can then be correlated to the mass domain. This speeds up and simplifies the analysis.

One of the main benefits of the FT-ICR technique is an inherent superior mass resolution over most other mass spectrometer techniques. Rather than a nominal mass resolution of “only” 100–1000 found in many other mass spectrometer techniques, mass resolutions of up to one million (or higher) are possible with FT-ICR instruments. They also provide phenomenal mass accuracy for precise component identification. So you may ask if an FT-ICR has such analytical power, why isn’t this technique more widely used? It was primarily due to cost and to the mechanical complexity of the instrument.



Figure 4: Analyser

Main Features

Analytical Power

High Mass Accuracy

One of the inherent advantages of ICR-based mass spectrometry is extremely accurate mass determination. Rather than unit mass accuracy found in comparably priced units, measurements to two or three decimal places is routine for the QUANTRA. This high mass accuracy can then be used to make positive component identification possible.

High Resolution

The power of high-resolution mass spectroscopy means that complex samples become simple to analyse. With an analysis free of many of the interferences that plague other systems, analysis is dramatically simplified while also increasing the confidence level of getting a true determination of the sample's composition.

Wide Mass Range

With a mass range of 12–1,000 amu, the QUANTRA can handle a wide range of applications. Furthermore, since the measurement of the entire range is done for each measurement, it is very easy to automatically measure unknown compounds.

Analytical Flexibility

The QUANTRA is fully compatible with a number of powerful application tools and techniques. These include Negative Ionisation, Chemical Ionisation, and Ion Ejection techniques. The analyser can also be coupled with a range of inlet devices such as Direct Insertion Probes, MIMS Probes, and Evolved Gas Analysis (EGA) devices like Thermo-Gravimetric and Purge and Trap units.



Figure 5: Measurement chamber

Robust Design

No Turbo Pump

Until the introduction of the QUANTRA, most mass spectrometers used mechanical and troublesome turbo pumps to maintain the vacuum needed for the analyser to work. These pumps often lead to high levels of maintenance as well as added cost to the analyser. The QUANTRA uses a much different design by using an electronic pump called an "ion pump". It has no moving parts and gives a much higher vacuum than is traditionally found with turbo pumps.

Unique Filament Design

Filaments have often been a source of routine maintenance for mass spectrometers; especially when measuring samples with corrosive or oxidizing chemicals. The QUANTRA is designed to avoid these problems by designing the filament such that it doesn't directly touch the sample. Furthermore, the QUANTRA uses only small amounts of sample so the exposure is further limited. Finally, the filament of the QUANTRA only operates in the nanoampere range of current versus the milliampere range traditionally found in other mass spectrometers.

High Life Injection Valves

The QUANTRA uses a "pulsed" sample approach for sample introduction. At user-selectable intervals (usually every second), a small amount of sample is injected into the measurement chamber by our specially designed injection valves. Up to three of these high-speed valves can be attached to each QUANTRA for maximum application flexibility.



Figure 6: Valve

PC Workstation

Temperature-Stabilized Measurement Chamber

A number of temperature control and heating systems are built into the QUANTRA. Not only will this minimize any effect ambient temperature swings will have on the unit, operation of the unit at temperatures up to 150 °C are possible for greater application flexibility.

Battery Back-up on Critical Systems

The QUANTRA has a trickle-charged battery back-up system in the event of a loss of primary power. For example, if power is lost, batteries will power the hard disk in the unit so that it shut downs properly. Also, the battery ensures that power is maintained on the ion pump in order to keep the measurement chamber at the operational pressure.

Simple Calibration

Calibration has always been a big problem for traditional mass spectrometers. Multiple calibration mixtures are needed to overcome the interferences of compounds with similar masses. And then complicated linear equations are used to help sort the interferences. The QUANTRA avoids this by avoiding most of the mass spectra interferences due to its inherent high mass resolution.

Remote Troubleshooting

The QUANTRA is capable of being accessed and controlled from remote locations using the Ethernet/Internet or modem connections. This coupled with our user-friendly software makes it easier to perform remote troubleshooting and monitoring of the unit; either by corporate technical experts or by Siemens maintenance personnel.

The QUANTRA system includes the ability to communicate, over Ethernet, to a PC workstation. The QUANTRA Workstation software operates on a Windows NT / 2000 platform and provides a convenient way to access the QUANTRA's analytical data as well as make changes to the analysis being performed.

The connection between the Workstation and the QUANTRA analyser is industry standard Ethernet with multiple analysers and workstations on the same network if desired. Remote access is also possible over the Internet and even modem connections if needed.

The QUANTRA user-friendly workstation software offers a number of features for monitoring and maintaining the analyser as well as setting up and optimizing analytical methods. These include:

- Live operational status window of important analytical and operational parameters
- Ability to display current and archived mass spectra as well as the original time-domain spectra
- Trend plots of up to 2 components on the Workstation screen
- Windows-based software with drop-down menus and layered display windows. Ability to take complete manual control of the operation of the instrument

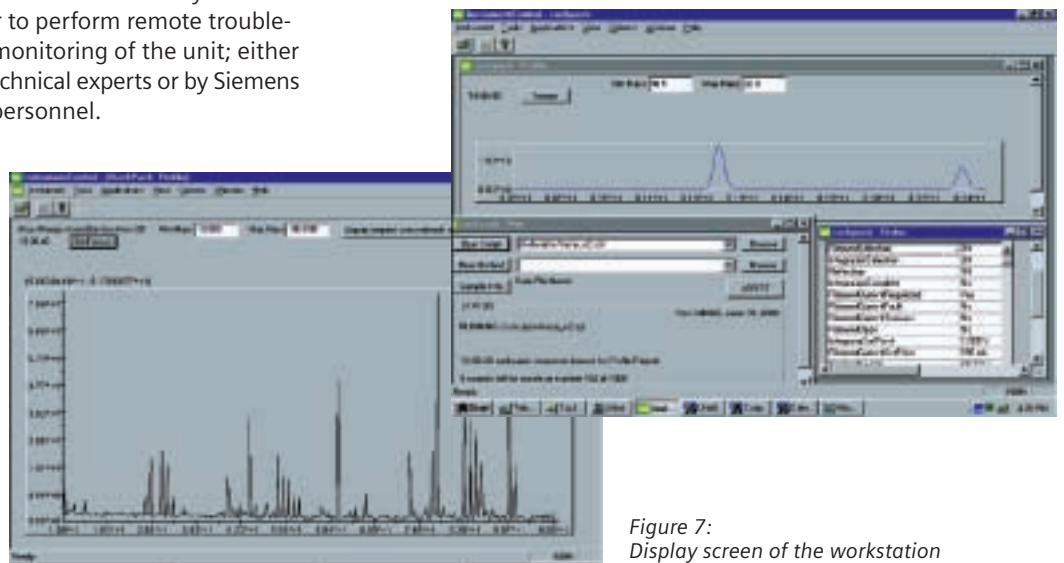

Figure 7:
Display screen of the workstation

Network Access Unit (NAU) for Process

For applications that require stream switching and those requiring diverse communications options our Network Access Unit (NAU) is available. The NAU is similarly used as an ancillary device for the popular Siemens GC analysers.

Stream Conditioning and Switching Systems

Up to 64 streams can be controlled and monitored by the NAU. Both traditional as well as rotary stream switching valves can be used. The NAU can also be configured to monitor sample stream temperature, pressure, and other operating parameters for improved system diagnostics.

Networking

The NAU also provides all the communication options developed for the Maxum GC product line. Communication is possible via Ethernet, Modbus, OPC, ASCII, or analog outputs.

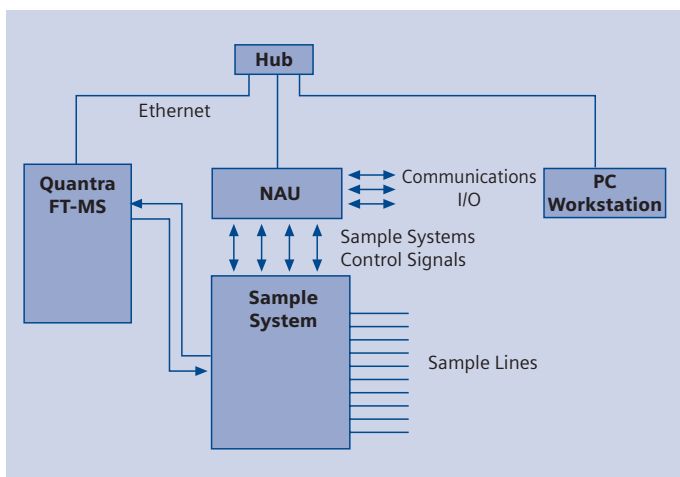

Figure 8: Network Access Unit for Process

Examples of the Power of High Resolution

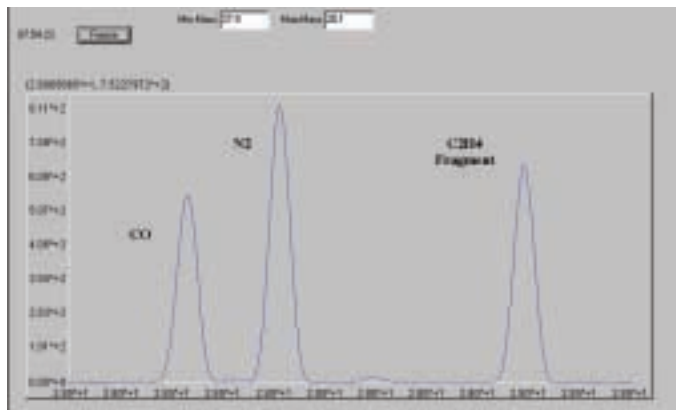

Figure 9: Even a C_2H_4 fragment has been detected

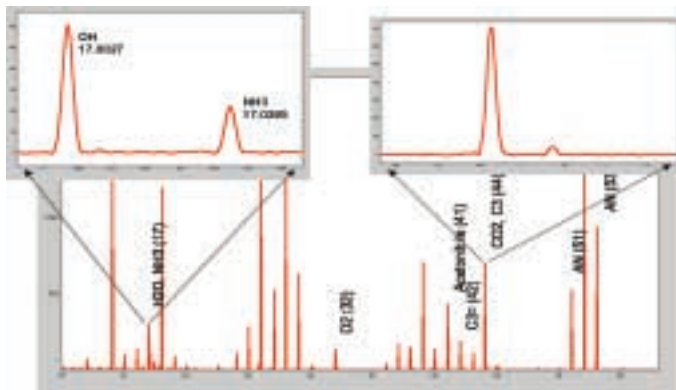

Figure 10: Acrylonitrile reactor stream

The interferences at the mass 17 and 44 are not quite measurable with a standard Quadrupole Mass Spectrometer.

Summary of Specs

Specifications	
Mass Range:	12–1,000 amu (2–11 amu upon request)
Mass Resolution:	20,000 @ 100 amu
Mass Accuracy:	10 ppm (0.0004 amu @ 28 amu)
Mass Repeatability:	50 ppm (0.0015 amu @ 28 amu)
Linearity:	Up to 3 orders of magnitude
Detection Limit:	Low ppm levels (application-dependent)
Number of trace components measured simultaneously:	No hardware or software limit
Measurement Cell Temperature:	150 °C
Vacuum Pump:	Internal 6.5 kV Ion Pump
Vacuum:	10 ⁻¹⁰ Torr l/s
Magnet Type:	Permanent 1-Tesla (nominal) Magnet
Dimensions:	1072 x 552 x 600 mm (h x w x d)
Weight:	115 kg
Power Consumption:	< 700 Watts
Power Requirements:	110/220 V AC, 50/60 Hz
Hazardous Area Classification:	General Purpose environments
Site Requirements:	Weather-protected. Ambient temperature from 10 °C to 40 °C; maximum of 50% relative humidity

Sample Inlet Conditions:

- Gas phase at the injection valves
- Pressure between 27 and 2,000 hPa
- Temperature between 25 and 150 °C
- Filtered down to 1 micron
- Flow rate of 0.5 to 200 ml/min

Summary

Most commercial FT-ICR systems cost in the high-level range and are extremely complex with cryogenically cooled magnet systems and elaborate vacuum pump systems. So up till now, this technique has been relegated to use by large research labs and academia. But Siemens has changed all of that with the introduction of the QUANTRA FT-ICR. Now the FT-ICR technology is affordable at prices comparable to most bench top mass spectrometers.

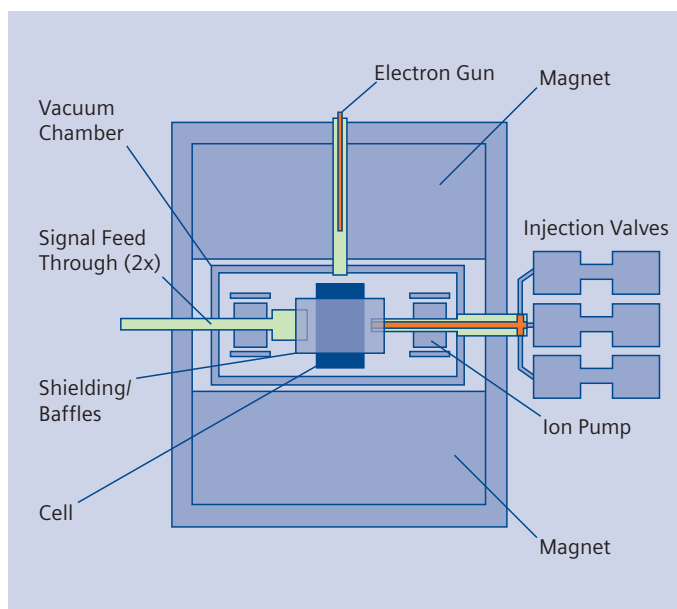

Figure 11: Schematic of the measuring chamber

If you have any questions, please contact your local sales representative or any of the contact addresses below.

Siemens AG
A&D PI 2 MS Process Analytics
Oestliche Rheinbrueckenstr. 50
76187 Karlsruhe
Germany
Tel.: +49 721 595 4234
Fax: +49 721 595 6375
E-mail: processanalytics@siemens.com
www.siemens.com/processanalytics

Siemens Applied Automation
500 West Highway 60
Bartlesville, OK 74003
USA
Tel.: +1 918 662 7000
Fax: +1 918 662 7052
E-mail: saaisales@sea.siemens.com
www.sea.siemens.com/ia

Siemens Pte. Limited
A&D PI 2 Regional Headquarter
The Siemens Center
60 MacPherson Road
Singapore 348615
Tel.: +65 6490 8702
Fax: +65 6490 8703
E-mail: splanalytics.sgp@siemens.com
www.siemens.com/processanalytics