

ACH200 Series High-voltage AC Drive



About us

Veichi (stock code: 688698) has always committed to electric drive and industrial control since its foundation. As an all-round company engaged in R & D, manufacturing and sales on high-tech industrial automation products, Veichi has been identified with several honorary titles such as Jiangsu Provincial-level Enterprise Technology Center, Jiangsu Private-own Technical Enterprise, Specialized and Sophisticated Enterprises That Produce New and Unique Products, Jiangsu Engineering Research Center, Jiangsu New and High-tech Enterprise and Suzhou City-level Gazelle Company (High Growth Enterprise) and has obtained the highest level of enterprise credit. Through years of independent research and development, Veichi now has been authorized with patents totaling 148 by the end of December, 2022, and among them 36 are for invention. Having established R & D center and manufacturing bases in Suzhou, Shenzhen and Xi'an, added with the wholly-owned subsidiary in India, Veichi now are dealing with customers from several nations and regions and has the full capability to provide safe, competitive and trustworthy products and services to customers from the larger world.

Veichi provides various products including drives from 0.4kW to 5,600kW, servo systems from 50W to 200kW, motion controllers, PLC and HMI, which are applied in all sorts of fields like lifting, mining, rail traffic, machine tools, compressors, plastic equipment, photo-voltaic pumping, construction, robots/mechanical arms, printing and packaging, chemical fibers for textile use, metallurgy, municipal works, petrol work and chemical engineering.

20 service stations and 182 contracted distributors cover 31 provinces on China mainland and Hong Kong, Macao and Taiwan regions, which guarantees a massive and efficient network for sales and services for our customers.

Veichi will continue to abide by the operation philosophy, that is, guided by market demand and driven by technological innovation, enlarge and enhance its core business like drives, servo systems, control systems and IoTs. And Veichi will always be devoted to providing quality products and services for customers and further make contributions to the development of electric drive and industrial control.

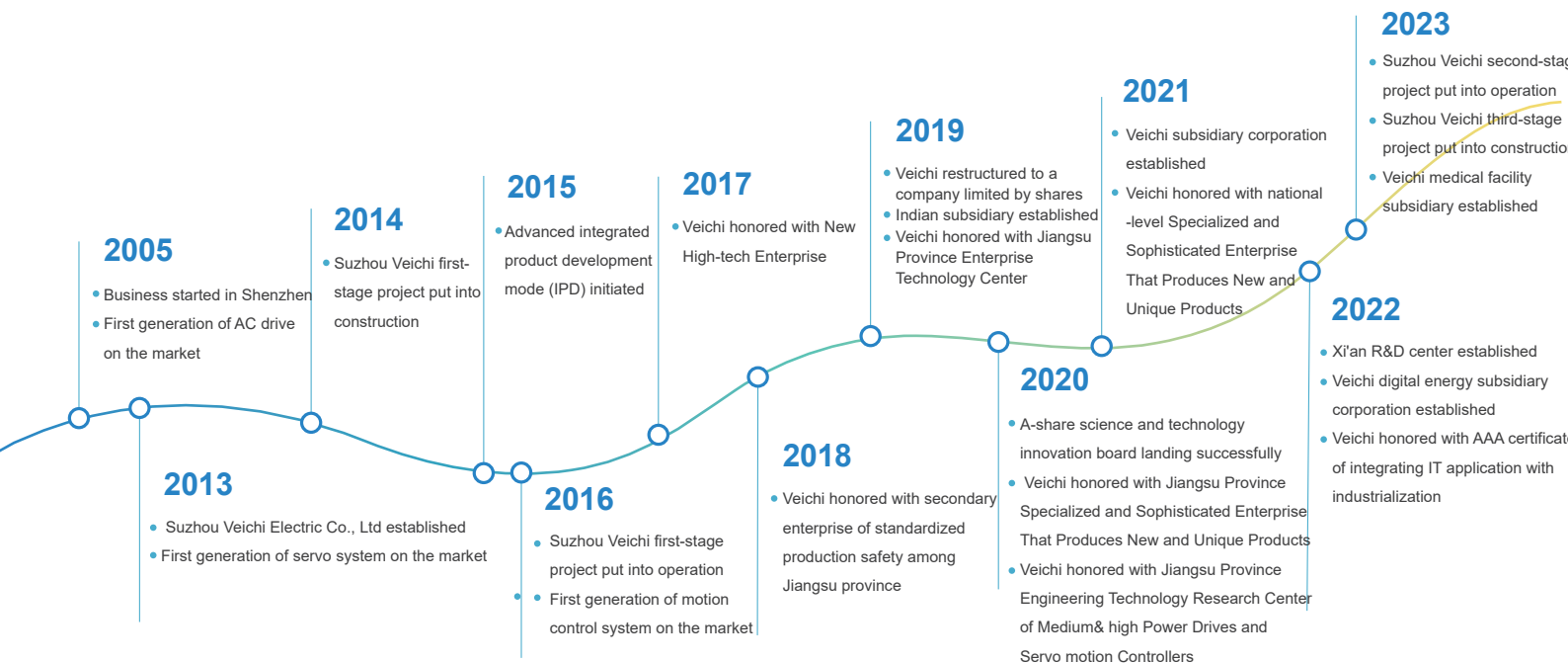

Brief

ACH200 series products are the third generation of high-performance high-voltage vector-type AC drive made by Veichi Electric on years of technical accumulation and in-depth market research and demand analysis, which adopts mature power unit series technology, DSP+FPGA dual core control, vector control algorithm, to deliver high control accuracy, fast dynamic response, large low frequency output torque etc. It is widely used in fans, pumps, compressors, belt machines, ball mills, crushers and other load occasions, providing the drive core for energy saving and emission reduction to meet the diversified needs of industrial enterprises.

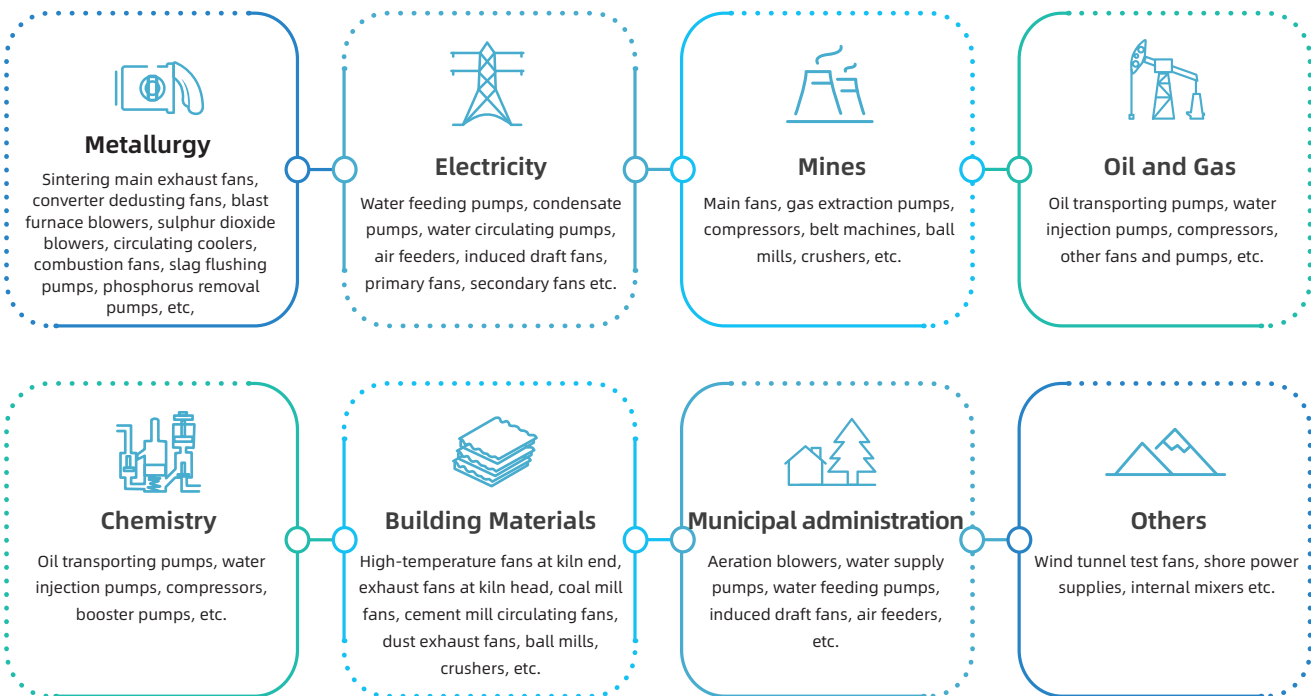

High-performance control platform

DSP+FPGA dual-chip control structure, control algorithms implemented by DSP, and external signals such as IO, bus and encoder processed by FPGA in parallel.
High-speed and high-precision loop control ensures the excellent dynamic response capability and control accuracy.

VF control, open/closed loop vector control

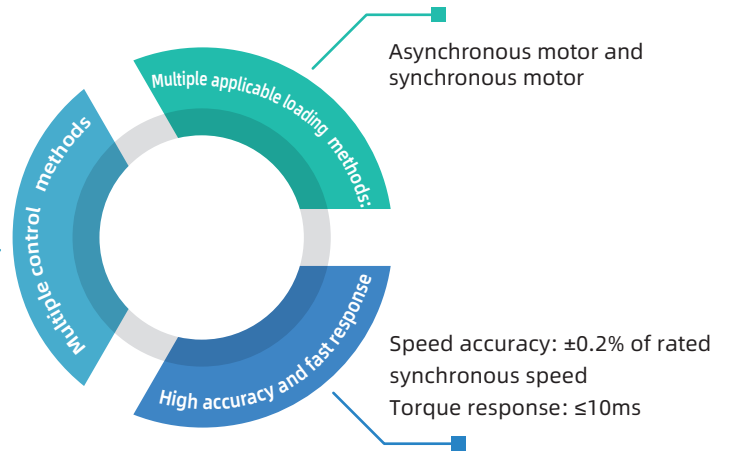

Start with high torque and low frequency

Open-loop vector control: 0.5Hz 150% starting torque.
Closed-loop vector control: 0Hz 200% starting torque.

200% rated torque output at 0Hz for IPM motors under open-loop control by high-frequency signal injection

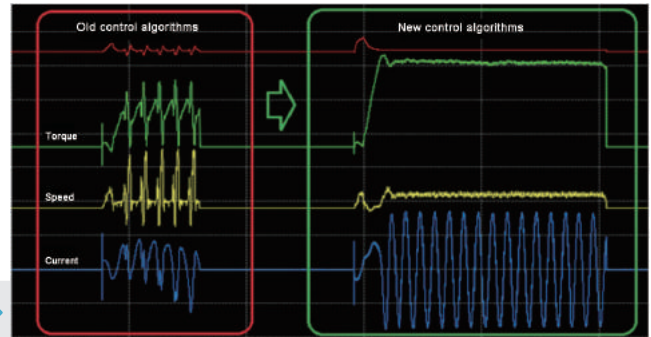

Excellent low frequency control performance

Dead-time compensation technology
Current waveform is nearly sine wave at low frequency

Low-frequency oscillation suppression algorithm
Motor resonance will not be caused at low frequency.

Current output waveform at 1Hz with load under vector control

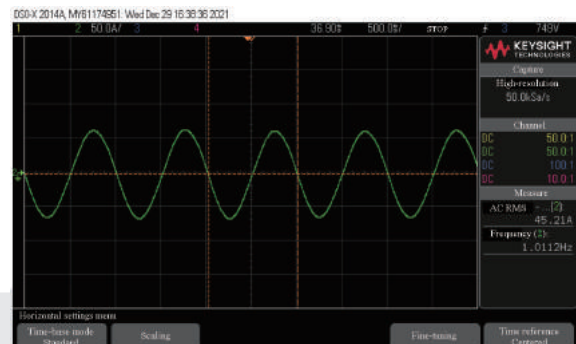

Stall protection for full frequency

Track rotational speed accurately regardless of the motor speed states. (forward, reverse, still)
 The whole process from starting to targeted state can be completed in shorter than 200ms with fast response.

Remanent voltage is larger at shutdown of large inertia equipment, so its remanent and phase can be estimated after restart, and then enter rotary preexcitation and acceleration.

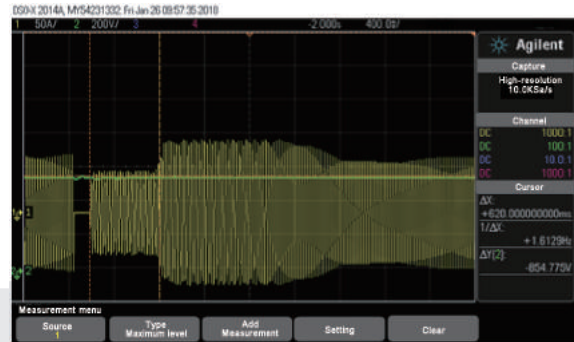

Master-slave control technology

CAN or fiber optic communication are adopted to ensure real-time communication and output consistency among multiple machines regardless of mechanical load and fluid load.

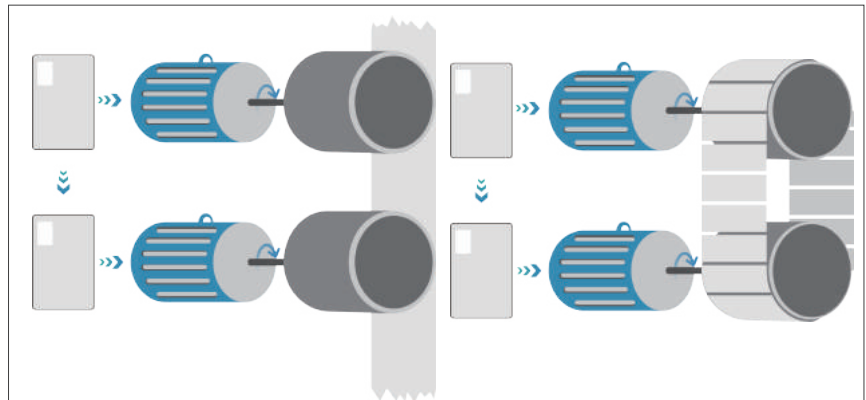
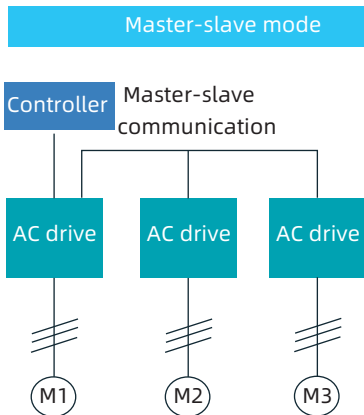

Advanced interfere-free switching technology

Phase-locked technology enables motor to start and run without interfere between power frequency and variable frequency, so it's suitable for switching between multi-gear water pumps
 The impact current of the switching process does not exceed 1.5 times of the rated motor current.

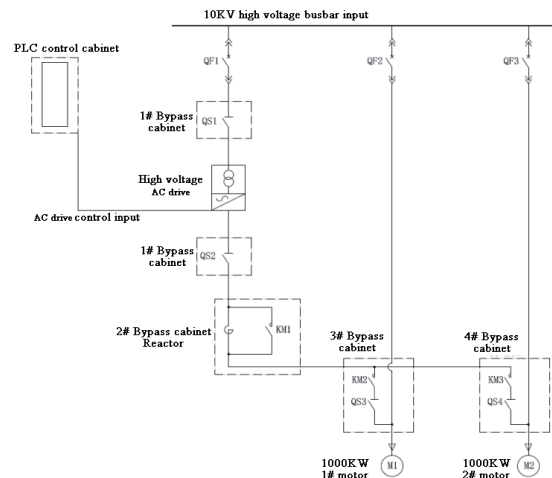

Ride-through design between low and high voltage

High adaptability to power grid fluctuations

- 85%-110% full-load output
- 65%-85% derated output
- 110%-120% derated output

Motor nonstop during instantaneous power cut for long running

- Motor will not shut down during short-time power down

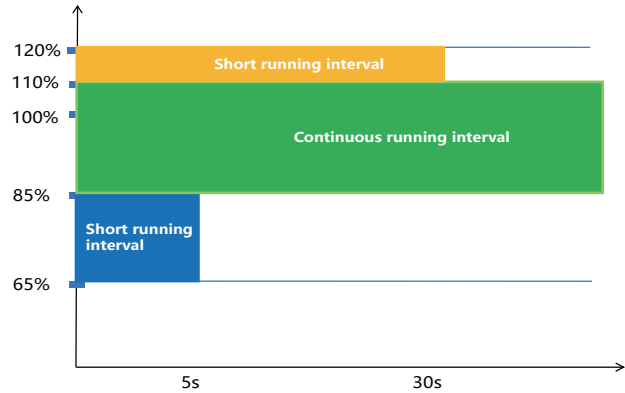

Perfect harmonic-free design

Multi-phase shift rectification technology on the input side

- Grid-side THD value smaller than 2%

Multi-level technology on the output side

- Motor-side THD value smaller than 2%

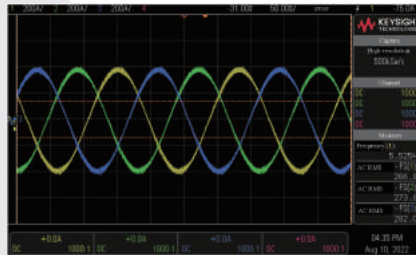

Harmonics to the motor <2% at rated load

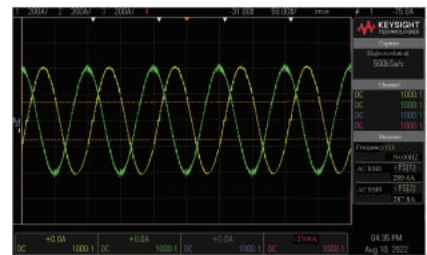

Harmonics to the grid <2% at rated load

Multiple unit bypass methods

- Parallel symmetric bypass
- Neutral offset bypass
- Standard with IGBT electronic bypass and optional with relay mechanical bypass

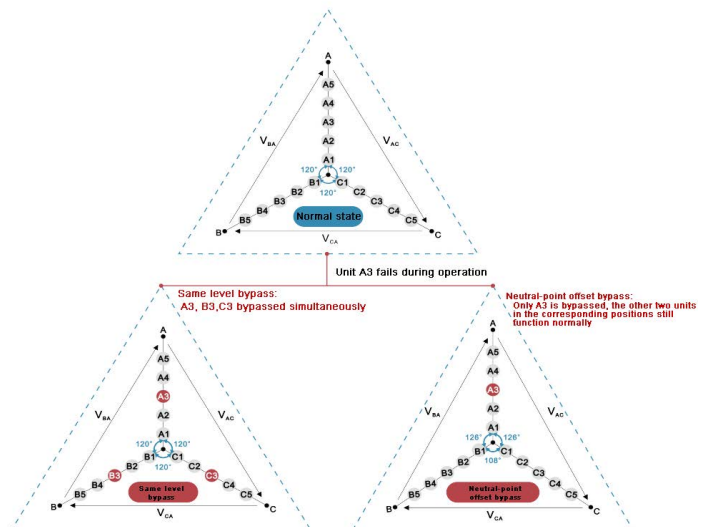

Multiple extension modes supported

Functional extensions according to actual requirements including IO extension, bus extension, encoder extension, etc.

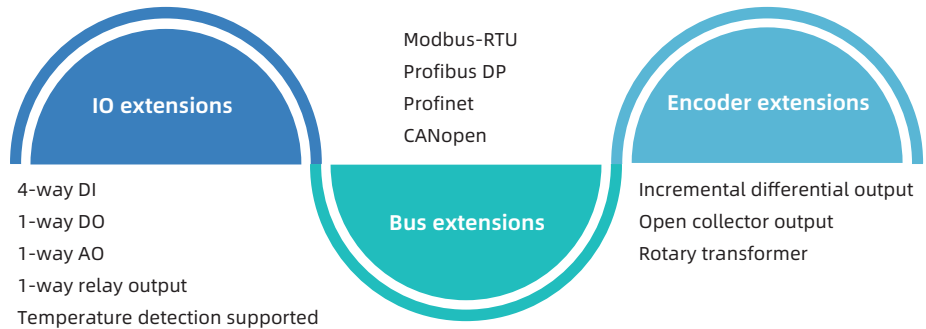

Multiple and comprehensive protections

Multiple fault handling and protection means for safety and stability.

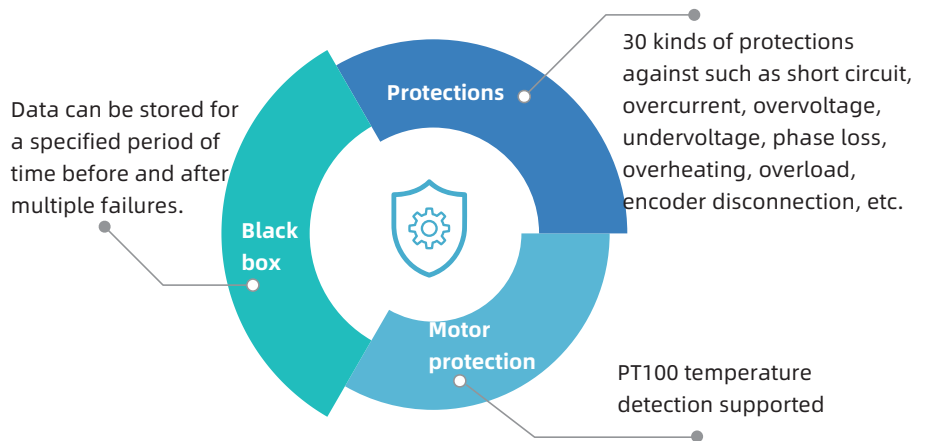

Remote diagnosis

Remote diagnosis is supported. After being authorized by clients, Veichi staff can check fault records, system parameters and running data to locate faults quickly, improving processes and efficiency on the remote server on the client's side via VPN.

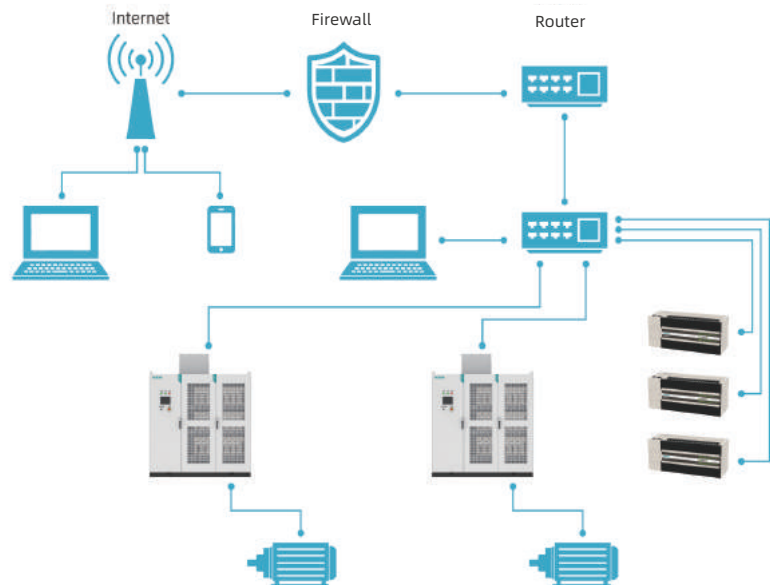

Name Rules

AC Drive Name Rules

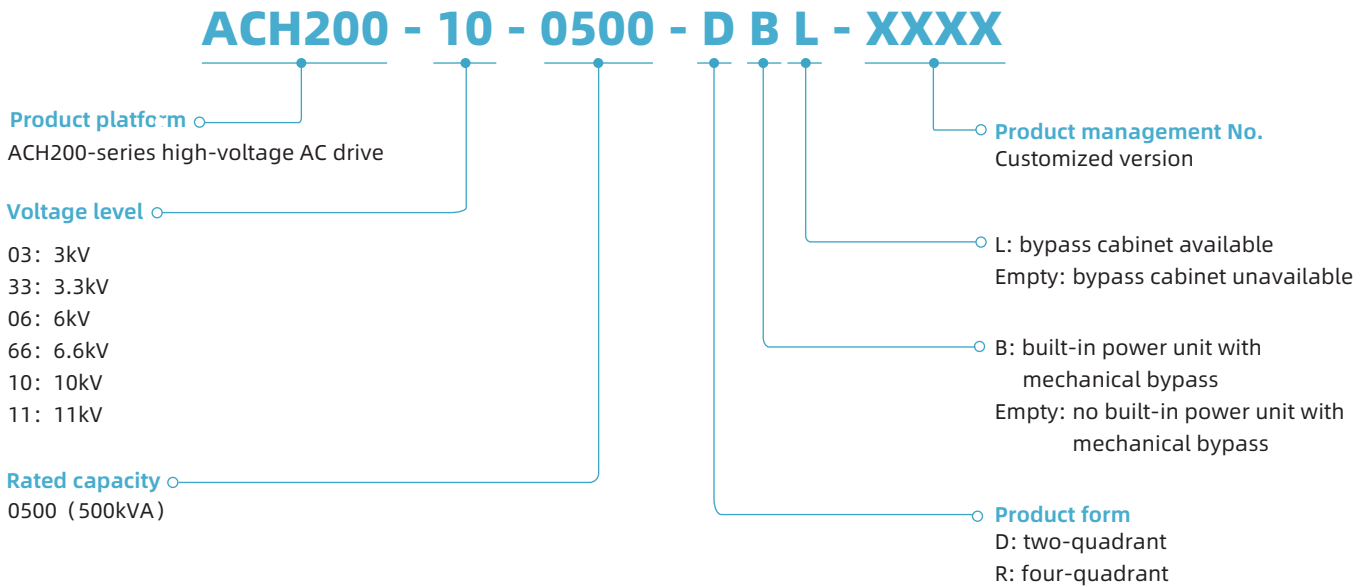

Bypass Name Rules

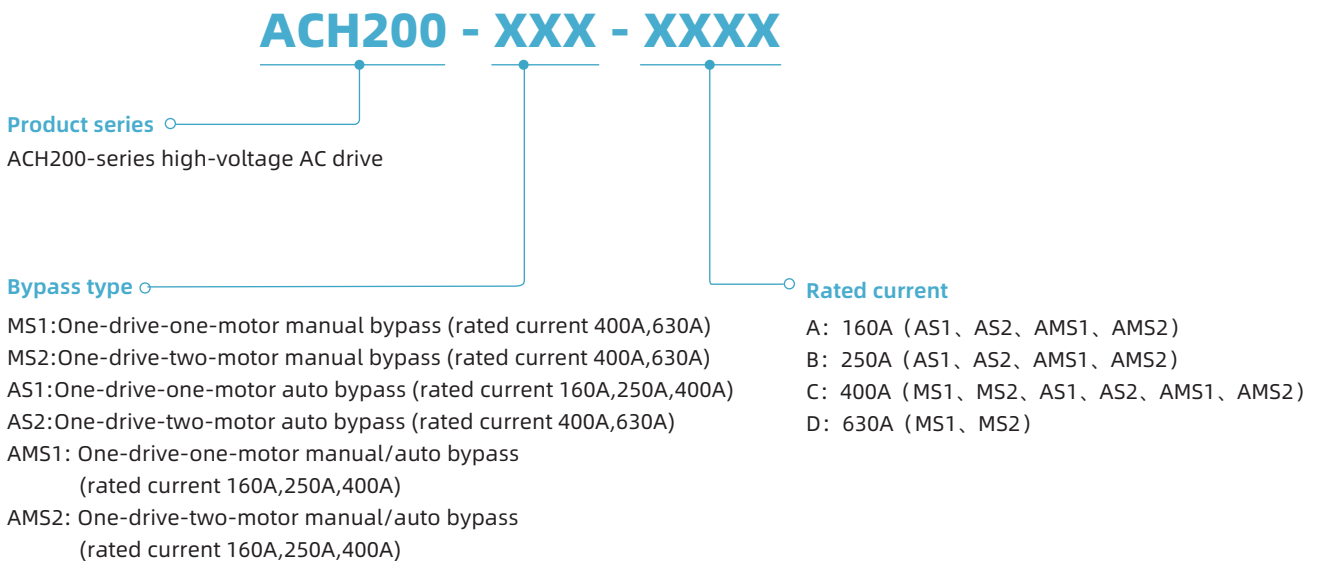

Cabinet Structure

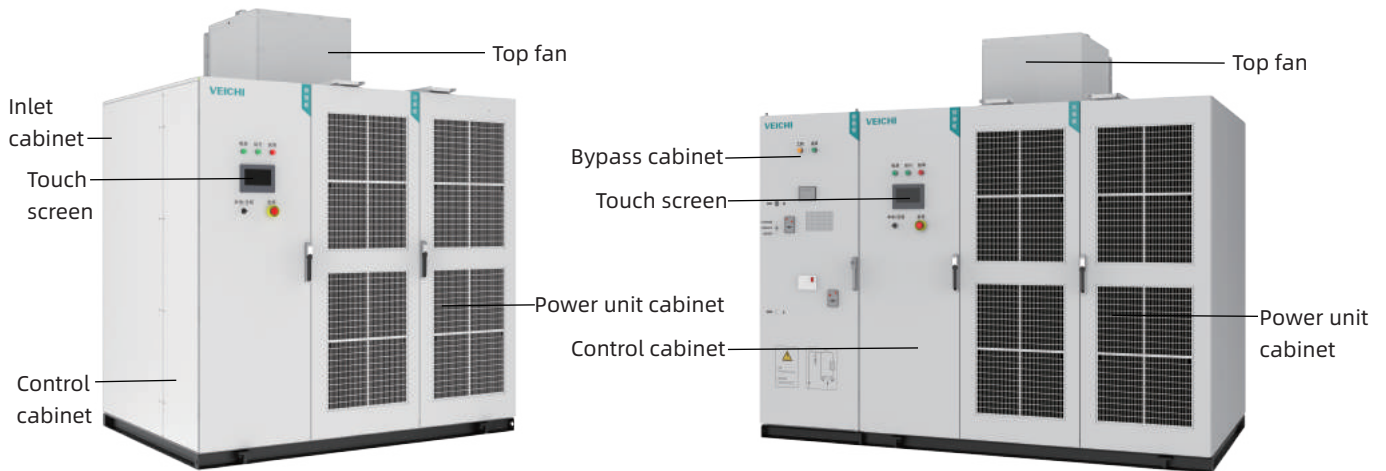

Bypass Solutions

One-drive-one-motor manual bypass

It consists of a single-pole single-throw disconnecter switch QS1 and a single-pole double-throw disconnecter switch QS2-a/QS2-b.

The manual bypass cabinet is designed in strict accordance with the "five-proof" interlocking requirements, and the drive output QS2-a and the bypass high-voltage disconnecter switch QS2-b are mechanically blocked, which can completely guarantee the safe running of the frequency conversion speed control system.

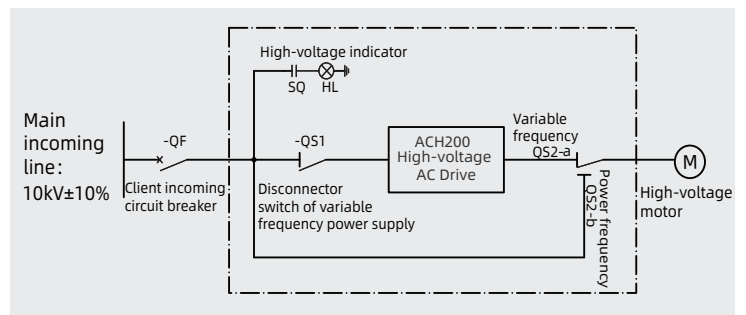

One-drive-one-motor auto bypass

It consists of three vacuum contactors KM1, KM2 and KM3.

The vacuum contactor of variable frequency output KM2 and the power frequency vacuum contactor KM3 are interlocked to ensure the safe running of the speed control system. Knife switches QS1 and QS2 have no mechanical locking function, but can be manually disconnected therefore to form an obvious disconnection point during maintenance for personal safety. They both remain closed under power frequency and variable frequency.

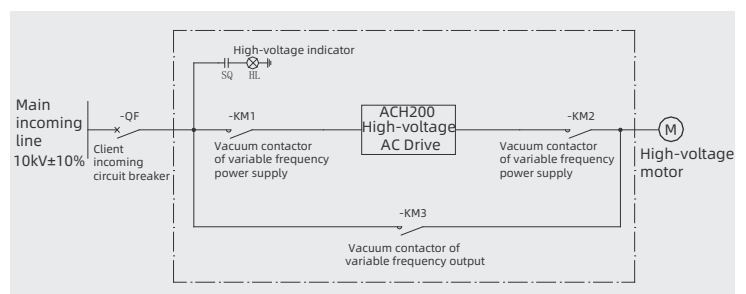

One-drive-one-motor manual/auto bypass

It consists of three vacuum contactors KM1, KM2, KM3 and two isolated knife-switches QS1 and QS2. The vacuum contactor of variable frequency output KM2 and the power frequency vacuum contactor KM3 are interlocked to ensure the safe running of the speed control system. Knife switches QS1 and QS2 have no mechanical locking function, but can be manually disconnected therefore to form an obvious disconnection point during maintenance for personal safety. They both remain closed under power frequency and variable frequency.

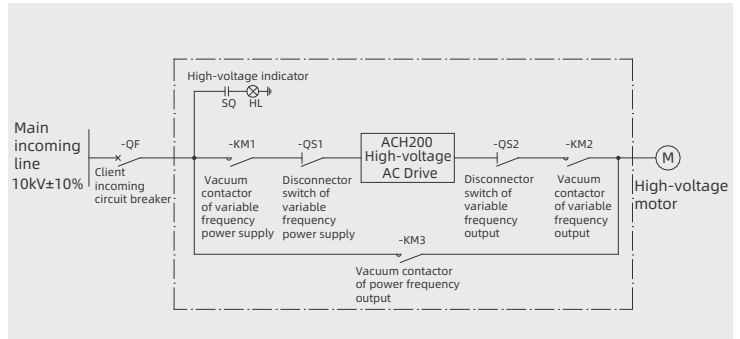

One-drive-two-motor manual bypass

The bypass cabinet 1 consists of a single-pole single-throw disconnecter switch QS1, a single-pole double-throw disconnecter switch QS2-a/QS2-b and a manual bypass cabinet. The manual bypass cabinet is designed in strict accordance with the "five-proof" interlocking requirements, the drive output QS2-a and the bypass high-voltage disconnecter switch QS2-b are mechanically blocked to ensure the safe running of the frequency conversion speed control system. Bypass cabinet 2 is the same as bypass cabinet 1.

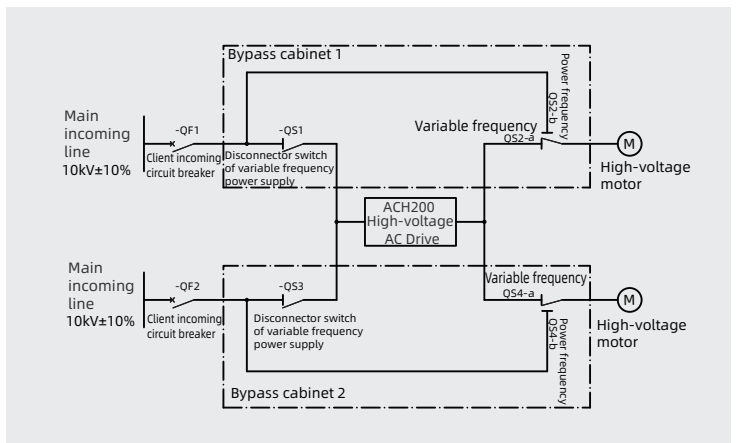

One-drive-two-motor auto bypass

Bypass cabinet 1 is mainly equipped with three vacuum contactors KM1, KM2, KM3. The vacuum contactor of variable frequency output KM2 and the power frequency vacuum contactor KM3 are interlocked to ensure the safe operation of the frequency conversion speed control system. Bypass cabinet 2 is the same as cabinet 1.

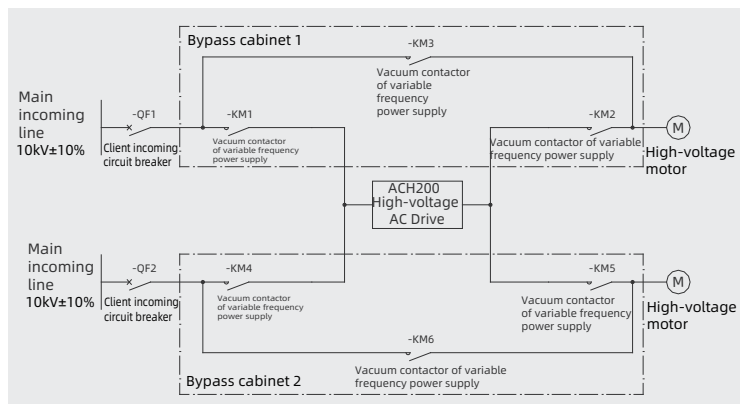

One-drive-two-motor manual/auto bypass

Bypass cabinet 1 is mainly equipped with three vacuum contactors KM1, KM2, KM3 and two knife switches QS1 and QS2. The drive output vacuum contactor KM2 and the frequency vacuum contactor KM3 are interlocked to ensure the safe operation of the drive speed control system. Knife switches QS1 and QS2 have no mechanical locking function, but are only manually disconnected to form an obvious disconnection point during maintenance to ensure personal safety. They both remain closed under power frequency and variable frequency.

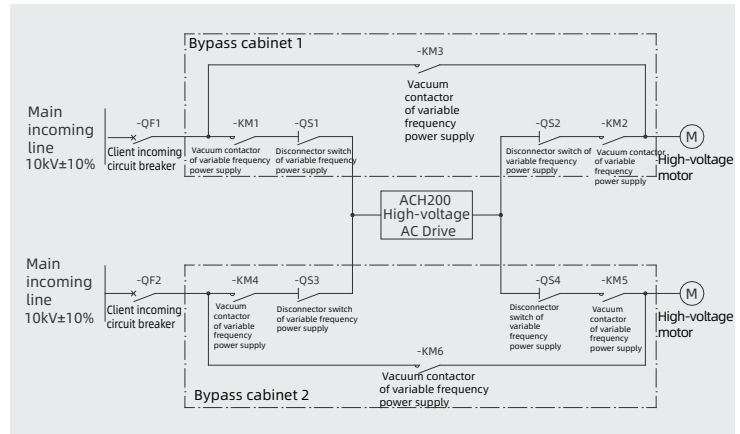

System Topology

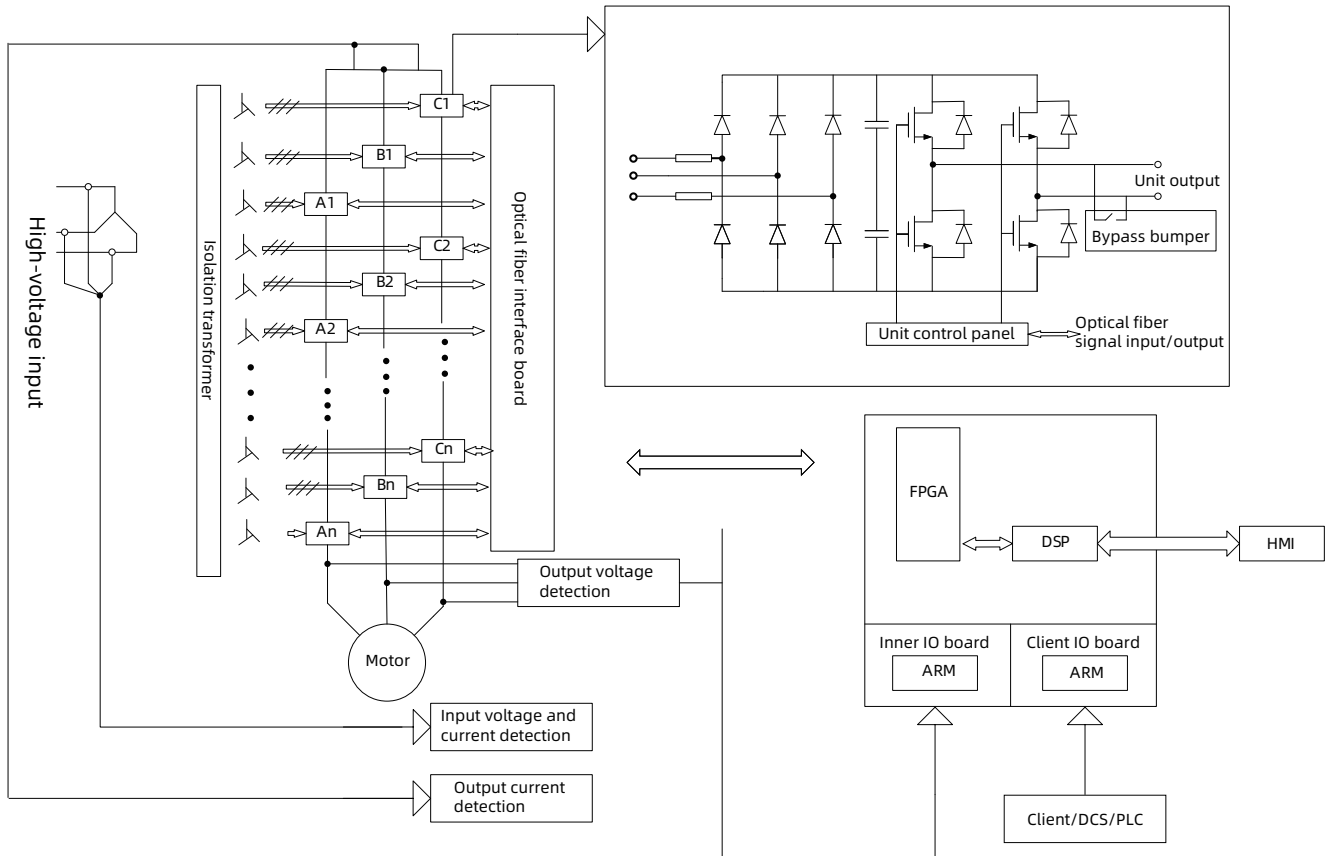

Standard IO Interface

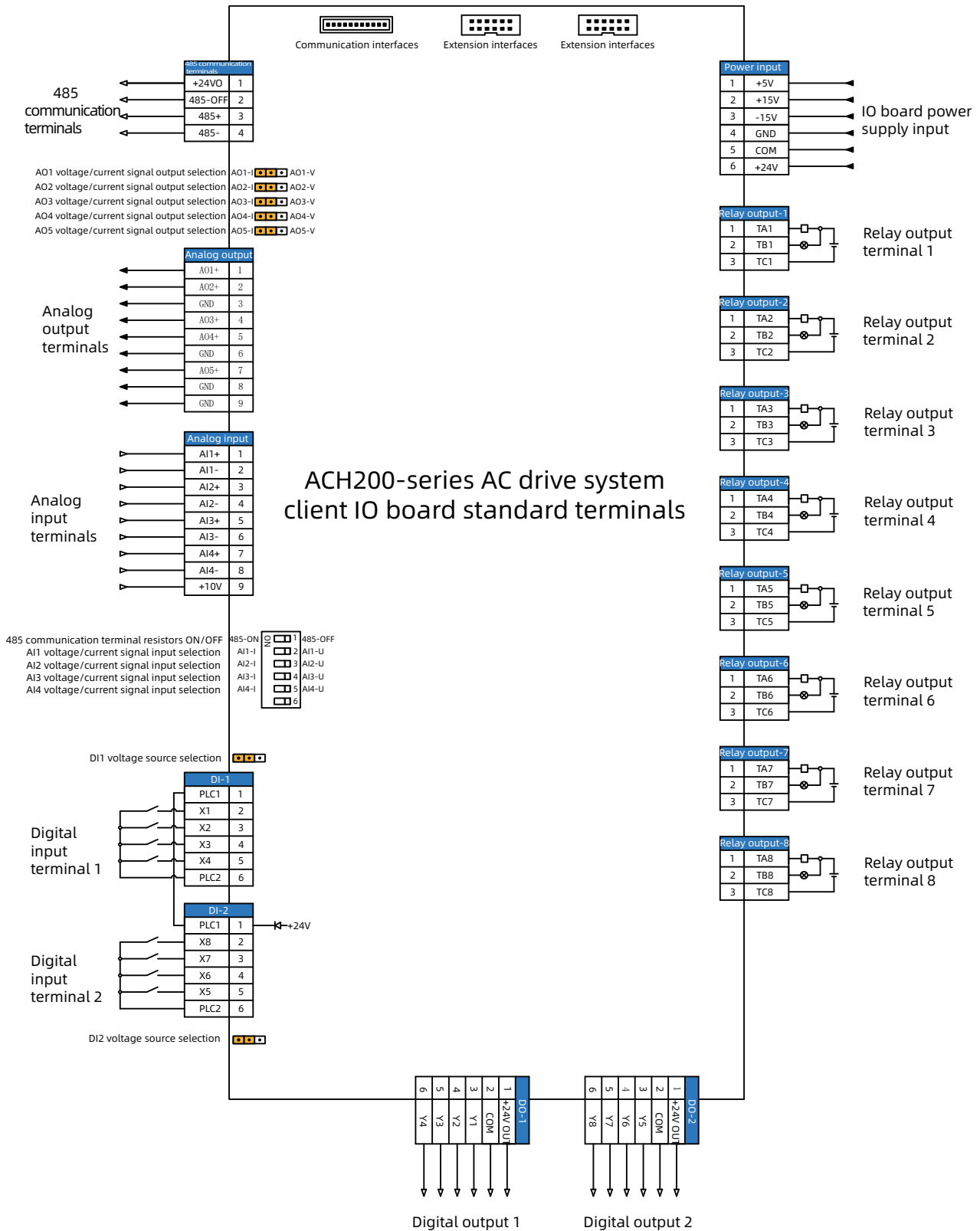



Technical Parameters



	Item	Specification
Input	Voltage level	3kV/3.3kV/6kV/6.6kV/10kV/11kV
	Voltage fluctuation range	-15%~+10%
	Voltage frequency	50/60Hz; ±5%
	Power factor	≥ 0.97 (at full load)
	System efficiency	≥ 96% (at full load)
	Current harmonics	≤4%
Output	Voltage range	0~rated input voltage
	Frequency range	0~120Hz(customizable)
	Current harmonics	≤4%
Control power	Voltage range	Three-phase four-wire 380V, ±10%, 50/60Hz
	Rated capacity	No lower than 10kVA
Control performance	Control mode	V/F control; vector control without PG (SVC); vector control with PG (FVC)
	Speed ratio	1:50 (VF) ; 1:100 (SVC) ; 1:200 (VC)
	Speed control accuracy	±1% (VF) ; ±0.4% (SVC) ; ±0.2% (VC)
	Torque response time	< 200ms (SVC) ; < 100ms (VC)
	Starting torque	150% rated torque at 0.5Hz (SVC); 180% rated torque at 0Hz (VC)
	Overload capacity	120%: 60s
	Acceleration/deceleration time	0-3600s(customizable)
User terminal	Switch input	8 -way digital inputs (extendable, programmable, which is compatible to 1 way of high-speed pulse input, input range: 0~50kHz)
	Switch output	8 -way digital outputs (extendable, programmable, which is compatible to 1 way of high-speed pulse input, input range: 0~50kHz)
	Relay output	8-way relay output (extendable, programmable)
	Analog input	4 ways: AI1、AI2、AI3、AI4: -10~+10V/0~20mA
	Analog output	5 ways: AO1、AO2、AO3、AO4、AO5: 0~+10V/0~20mA
Protection	System protection	Overcurrent, overvoltage, undervoltage, motor overload, drive overload, phase loss, overheating, temperature controller failure, access control failure, communication failure, etc.
	Unit protection	Undervoltage, overvoltage, power supply, overheating, input phase failure, module failure, power supply failure, communication failure, bypass failure, etc.
Others	HMI	Touch screen
	Communication method	Modbus protocol supported (standard RS485 interface), CANopen, Profibus DP, Profinet and Ethernet methods are optional
	Installation method	Cabinet installation
	Protection level	IP30
	Noise level	≤75dB
	In/Out Line Method	Bottom in and bottom out, other methods optional
	Cooling method	Forced air cooling
	Control power	AC 380V±10%
	MTBF	50000h
	Ambient temperature	-5°C~+40°C, derate above 40°C, the highest working temperature is 50°C, derate capacity by 1.5% for each 1°C increase
	Ambient humidity	5%~95%, no condensation
	Altitude Below	1000m, derate when higher than 1000m. derate capacity by 1% for each 100m increase
	Storage environment	Stored in places with no dust, no direct sunlight, no combustible or corrosive gases, no oil, no water vapor and vibration
Vibration range	Below 0.59	

Product Specification(Standard)



3KV

Look	Model	Rated power (kW)	Rated current (A)	Dimension W*D*H(mm)	Weight (kg)
	ACH200-03-0280-D	220	54	2100X1450X2000	1310
	ACH200-03-0315-D	250	61	2100X1450X2000	1350
	ACH200-03-0355-D	280	68	2100X1450X2000	1380
	ACH200-03-0400-D	315	77	2100X1450X2000	1400
	ACH200-03-0450-D	355	87	2100X1450X2000	1450
	ACH200-03-0500-D	400	96	2100X1450X2000	1550
	ACH200-03-0560-D	450	108	2700X1650X2000	1600
	ACH200-03-0630-D	500	121	2700X1650X2000	1680
	ACH200-03-0710-D	560	137	2700X1650X2000	1750



3.3KV

Look	Model	Rated power (kW)	Rated current (A)	Dimension W*D*H(mm)	Weight (kg)
	ACH200-33-0280-D	220	49	2100X1450X2000	1330
	ACH200-33-0315-D	250	55	2100X1450X2000	1370
	ACH200-33-0355-D	280	62	2100X1450X2000	1400
	ACH200-33-0400-D	315	70	2100X1450X2000	1430
	ACH200-33-0450-D	355	79	2100X1450X2000	1480
	ACH200-33-0500-D	400	87	2100X1450X2000	1580
	ACH200-33-0560-D	450	98	2100X1450X2000	1630
	ACH200-33-0630-D	500	110	2700X1650X2000	1710
	ACH200-33-0710-D	560	124	2700X1650X2000	1790
	ACH200-33-0800-D	630	140	2700X1650X2000	1890



6KV

Look	Model	Rated power (kW)	Rated current (A)	Dimension W*D*H(mm)	Weight (kg)
	ACH200-06-0400-D	315	38	2100X1450X2000	1740
	ACH200-06-0450-D	355	43	2100X1450X2000	1800
	ACH200-06-0500-D	400	48	2100X1450X2000	1920
	ACH200-06-0560-D	450	54	2100X1450X2000	1970
	ACH200-06-0630-D	500	61	2100X1450X2000	2060
	ACH200-06-0710-D	560	68	2100X1450X2000	2150
	ACH200-06-0800-D	630	77	2100X1450X2000	2200
	ACH200-06-0900-D	710	87	2100X1450X2000	2320
	ACH200-06-1000-D	800	96	2100X1450X2000	2410
	ACH200-06-1120-D	900	108	2700X1650X2000	2950
	ACH200-06-1250-D	1000	120	2700X1650X2000	2100
	ACH200-06-1400-D	1120	135	2700X1650X2000	3310



6.6KV

Look	Model	Rated power (kW)	Rated current (A)	Dimension W*D*H(mm)	Weight (kg)
	ACH200-66-0400-D	315	35	2100X1450X2000	1790
	ACH200-66-0450-D	355	39	2100X1450X2000	1850
	ACH200-66-0500-D	400	44	2100X1450X2000	1980
	ACH200-66-0560-D	450	49	2100X1450X2000	2090
	ACH200-66-0630-D	500	55	2100X1450X2000	2120
	ACH200-66-0710-D	560	62	2100X1450X2000	2210
	ACH200-66-0800-D	630	70	2100X1450X2000	2260
	ACH200-66-0900-D	710	79	2100X1450X2000	2390
	ACH200-66-1000-D	800	87	2100X1450X2000	2480
	ACH200-66-1120-D	900	98	2100X1450X2000	3030
	ACH200-66-1250-D	1000	109	2700X1650X2000	2160
	ACH200-66-1400-D	1120	122	2700X1650X2000	3400
	ACH200-66-1600-D	1250	140	2700X1650X2000	3350

10KV

Look	Model	Rated power (kW)	Rated current (A)	Dimension W*D*H(mm)	Weight (kg)
	ACH200-10-0500-D	400	29	2100X1450X2000	2270
	ACH200-10-0560-D	450	32	2100X1450X2000	2320
	ACH200-10-0630-D	500	36	2100X1450X2000	2370
	ACH200-10-0710-D	560	40	2100X1450X2000	2420
	ACH200-10-0800-D	630	46	2100X1450X2000	2520
	ACH200-10-0900-D	710	52	2100X1450X2000	2570
	ACH200-10-1000-D	800	58	2100X1450X2000	2620
	ACH200-10-1120-D	900	65	2100X1450X2000	2770
	ACH200-10-1250-D	1000	72	2100X1450X2000	2820
		ACH200-10-1400-D	1120	81	2700X1650X2000
ACH200-10-1600-D		1250	92	2700X1650X2000	3620
ACH200-10-1800-D		1400	100	2700X1650X2000	3770
ACH200-10-2000-D		1600	115	2700X1650X2000	3920
ACH200-10-2240-D		1800	129	2700X1650X2000	4170
ACH200-10-2500-D	2000	144	2700X1650X2000	4370	

11KV



Look	Model	Rated power (kW)	Rated current (A)	Dimension W*D*H(mm)	Weight (kg)
	ACH200-11-0500-D	400	26	2100X1450X2000	2330
	ACH200-11-0560-D	450	29	2100X1450X2000	2390
	ACH200-11-0630-D	500	33	2100X1450X2000	2440
	ACH200-11-0710-D	560	37	2100X1450X2000	2500
	ACH200-11-0800-D	630	42	2100X1450X2000	2600
	ACH200-11-0900-D	710	47	2100X1450X2000	2650
	ACH200-11-1000-D	800	52	2100X1450X2000	2700
	ACH200-11-1120-D	900	59	2100X1450X2000	2850
	ACH200-11-1250-D	1000	66	2100X1450X2000	2900
		ACH200-11-1400-D	1120	73	2700X1650X2000
ACH200-11-1600-D		1250	84	2700X1650X2000	2720
ACH200-11-1800-D		1400	94	2700X1650X2000	3880
ACH200-11-2000-D		1600	105	2700X1650X2000	4000
ACH200-11-2240-D		1800	118	2700X1650X2000	4300
ACH200-11-2500-D		2000	131	2700X1650X2000	4500

Notes:



- The above dimensions and weights are just for reference, please refer to the technical agreement for specific values;
- The size of the whole machine does not include that of the fan on the top of the cabinet, so it will increase by 300mm-600mm, please see the technical agreement for details;
- The front of the equipment from the wall / other equipment distance is recommended not closer than 1500mm, the back from the wall / other equipment distance is recommended not closer than 1000mm, the side from the wall / other equipment distance is recommended not closer than 800mm, the top distance from the roof is recommended to be not closer than 1000mm.

Product Specification (with Bypass Cabinet)



3KV

Look	Model	Rated power (kW)	Rated current (A)	Dimension W*D*H(mm)	Weight (kg)	One-drive-one-motor manual bypass (recommended)	Dimension W*D*H(mm)	Weight (kg)	One-drive-one-motor auto bypass (recommended)	Dimension W*D*H(mm)	Weight (kg)
	ACH200-03-0280-DL	220	54	2100X1450X2000	1310	ACH200-MS1-C	700X1450X2000	350	ACH200-AS1-A	700X1450X2000	450
	ACH200-03-0315-DL	250	61	2100X1450X2000	1350		700X1450X2000	350		700X1450X2000	450
	ACH200-03-0355-DL	280	68	2100X1450X2000	1380		700X1450X2000	350		700X1450X2000	450
	ACH200-03-0400-DL	315	77	2100X1450X2000	1400		700X1450X2000	350		700X1450X2000	450
	ACH200-03-0450-DL	355	87	2100X1450X2000	1450		700X1450X2000	350		700X1450X2000	450
ACH200-03-0500-DL	400	96	2100X1450X2000	1550	700X1450X2000		350	700X1450X2000		450	
	ACH200-03-0560-DL	450	108	2700X1650X2000	1600		700X1650X2000	430		700X1650X2000	530
	ACH200-03-0630-DL	500	121	2700X1650X2000	1680		700X1650X2000	430		700X1650X2000	530
	ACH200-03-0710-DL	560	137	2700X1650X2000	1750		700X1650X2000	430		700X1650X2000	530



3.3KV

Look	Model	Rated power (kW)	Rated current (A)	Dimension W*D*H(mm)	Weight (kg)	One-drive-one-motor manual bypass (recommended)	Dimension W*D*H(mm)	Weight (kg)	One-drive-one-motor auto bypass (recommended)	Dimension W*D*H(mm)	Weight (kg)
	ACH200-33-0280-DL	220	49	2100X1450X2000	1330	ACH200-MS1-C	700X1450X2000	350	ACH200-AS1-A	700X1450X2000	450
	ACH200-33-0315-DL	250	55	2100X1450X2000	1370		700X1450X2000	350		700X1450X2000	450
	ACH200-33-0355-DL	280	62	2100X1450X2000	1400		700X1450X2000	350		700X1450X2000	450
	ACH200-33-0400-DL	315	70	2100X1450X2000	1430		700X1450X2000	350		700X1450X2000	450
	ACH200-33-0450-DL	355	79	2100X1450X2000	1480		700X1450X2000	350		700X1450X2000	450
ACH200-33-0500-DL	400	87	2100X1450X2000	1580	700X1450X2000		350	700X1450X2000		450	
ACH200-33-0560-DL	450	98	2100X1450X2000	1630	700X1450X2000		350	700X1450X2000		450	
	ACH200-33-0630-DL	500	110	2700X1650X2000	1710		700X1650X2000	430		700X1650X2000	530
	ACH200-33-0710-DL	560	124	2700X1650X2000	1790		700X1650X2000	430		700X1650X2000	530
	ACH200-33-0800-DL	630	140	2700X1650X2000	1890		700X1650X2000	430		700X1650X2000	530

6KV

Look	Model	Rated power (kW)	Rated current (A)	Dimension W*D*H(mm)	Weight (kg)	One-drive-one-motor manual bypass (recommended)	Dimension W*D*H(mm)	Weight (kg)	One-drive-one-motor auto bypass (recommended)	Dimension W*D*H(mm)	Weight (kg)
	ACH200-06-0400-DL	315	38	2100X1450X2000	1740	ACH200-MS1-C	700X1450X2000	350	ACH200-AS1-A	700X1450X2000	450
	ACH200-06-0450-DL	355	43	2100X1450X2000	1800		700X1450X2000	350		700X1450X2000	450
	ACH200-06-0500-DL	400	48	2100X1450X2000	1920		700X1450X2000	350		700X1450X2000	450
	ACH200-06-0560-DL	450	54	2100X1450X2000	1970		700X1450X2000	350		700X1450X2000	450
	ACH200-06-0630-DL	500	61	2100X1450X2000	2060		700X1450X2000	350		700X1450X2000	450
	ACH200-06-0710-DL	560	68	2100X1450X2000	2150		700X1450X2000	350		700X1450X2000	450
	ACH200-06-0800-DL	630	77	2100X1450X2000	2200		700X1450X2000	350		700X1450X2000	450
ACH200-06-0900-DL	710	87	2100X1450X2000	2320	700X1450X2000		350	700X1450X2000		450	
ACH200-06-1000-DL	800	96	2100X1450X2000	2410	700X1450X2000		350	700X1450X2000		450	
	ACH200-06-1120-DL	900	108	2700X1650X2000	2950		700X1650X2000	430		700X1650X2000	530
	ACH200-06-1250-DL	1000	120	2700X1650X2000	2100	700X1650X2000	430	700X1650X2000	530		
	ACH200-06-1400-DL	1120	135	2700X1650X2000	3310	700X1650X2000	430	700X1650X2000	530		

6.6KV

Look	Model	Rated power (kW)	Rated current (A)	Dimension W*D*H(mm)	Weight (kg)	One-drive-one-motor manual bypass (recommended)	Dimension W*D*H(mm)	Weight (kg)	One-drive-one-motor auto bypass (recommended)	Dimension W*D*H(mm)	Weight (kg)
	ACH200-66-0400-DL	315	35	2100X1450X2000	1790	ACH200-MS1-C	700X1450X2000	350	ACH200-AS1-A	700X1450X2000	450
	ACH200-66-0450-DL	355	39	2100X1450X2000	1850		700X1450X2000	350		700X1450X2000	450
	ACH200-66-0500-DL	400	44	2100X1450X2000	1980		700X1450X2000	350		700X1450X2000	450
	ACH200-66-0560-DL	450	49	2100X1450X2000	2090		700X1450X2000	350		700X1450X2000	450
	ACH200-66-0630-DL	500	55	2100X1450X2000	2120		700X1450X2000	350		700X1450X2000	450
	ACH200-66-0710-DL	560	62	2100X1450X2000	2210		700X1450X2000	350		700X1450X2000	450
	ACH200-66-0800-DL	630	70	2100X1450X2000	2260		700X1450X2000	350		700X1450X2000	450
	ACH200-66-0900-DL	710	79	2100X1450X2000	2390		700X1450X2000	350		700X1450X2000	450
	ACH200-66-1000-DL	800	87	2100X1450X2000	2480		700X1450X2000	350		700X1450X2000	450
	ACH200-66-1120-DL	900	98	2100X1450X2000	3030	ACH200-MS1-C	700X1450X2000	350	ACH200-AS1-A	700X1450X2000	450
	ACH200-66-1250-DL	1000	109	2700X1650X2000	2160		700X1650X2000	430		700X1650X2000	530
	ACH200-66-1400-DL	1120	122	2700X1650X2000	3400		700X1650X2000	430		700X1650X2000	530
	ACH200-66-1600-DL	1250	140	2700X1650X2000	3350		700X1650X2000	430		700X1650X2000	530

10KV

Look	Model	Rated power (kW)	Rated current (A)	Dimension W*D*H(mm)	Weight (kg)	One-drive-one-motor manual bypass (recommended)	Dimension W*D*H(mm)	Weight (kg)	One-drive-one-motor auto bypass (recommended)	Dimension W*D*H(mm)	Weight (kg)
	ACH200-10-0500-DL	400	29	2100X1450X2000	2270	ACH200-MS1-C	700X1450X2000	350	ACH200-AS1-A	700X1450X2000	450
	ACH200-10-0560-DL	450	32	2100X1450X2000	2320		700X1450X2000	350		700X1450X2000	450
	ACH200-10-0630-DL	500	36	2100X1450X2000	2370		700X1450X2000	350		700X1450X2000	450
	ACH200-10-0710-DL	560	40	2100X1450X2000	2420		700X1450X2000	350		700X1450X2000	450
	ACH200-10-0800-DL	630	46	2100X1450X2000	2520		700X1450X2000	350		700X1450X2000	450
	ACH200-10-0900-DL	710	52	2100X1450X2000	2570		700X1450X2000	350		700X1450X2000	450
	ACH200-10-1000-DL	800	58	2100X1450X2000	2620		700X1450X2000	350		700X1450X2000	450
	ACH200-10-1120-DL	900	65	2100X1450X2000	2770		700X1450X2000	350		700X1450X2000	450
	ACH200-10-1250-DL	1000	72	2100X1450X2000	2820		700X1450X2000	350		700X1450X2000	450
	ACH200-10-1400-DL	1120	81	2700X1650X2000	3420	ACH200-MS1-C	700X1650X2000	430	ACH200-AS1-A	700X1650X2000	530
	ACH200-10-1600-DL	1250	92	2700X1650X2000	3620		700X1650X2000	430		700X1650X2000	530
	ACH200-10-1800-DL	1400	100	2700X1650X2000	3770		700X1650X2000	430		700X1650X2000	530
	ACH200-10-2000-DL	1600	115	2700X1650X2000	3920		700X1650X2000	430		700X1650X2000	530
	ACH200-10-2240-DL	1800	129	2700X1650X2000	4170		700X1650X2000	430		700X1650X2000	530
ACH200-10-2500-DL	2000	144	2700X1650X2000	4370	700X1650X2000	430	700X1650X2000	530			

11KV

Look	Model	Rated power (kW)	Rated current (A)	Dimension W*D*H(mm)	Weight (kg)	One-drive-one-motor manual bypass (recommended)	Dimension W*D*H(mm)	Weight (kg)	One-drive-one-motor auto bypass (recommended)	Dimension W*D*H(mm)	Weight (kg)
	ACH200-11-0500-DL	400	26	2100X1450X2000	2330	ACH200-MS1-C	700X1450X2000	350	ACH200-AS1-A	700X1450X2000	450
	ACH200-11-0560-DL	450	29	2100X1450X2000	2390		700X1450X2000	350		700X1450X2000	450
	ACH200-11-0630-DL	500	33	2100X1450X2000	2440		700X1450X2000	350		700X1450X2000	450
	ACH200-11-0710-DL	560	37	2100X1450X2000	2500		700X1450X2000	350		700X1450X2000	450
	ACH200-11-0800-DL	630	42	2100X1450X2000	2600		700X1450X2000	350		700X1450X2000	450
	ACH200-11-0900-DL	710	47	2100X1450X2000	2650		700X1450X2000	350		700X1450X2000	450
	ACH200-11-1000-DL	800	52	2100X1450X2000	2700		700X1450X2000	350		700X1450X2000	450
	ACH200-11-1120-DL	900	59	2100X1450X2000	2850		700X1450X2000	350		700X1450X2000	450
	ACH200-11-1250-DL	1000	66	2100X1450X2000	2900		700X1450X2000	350		700X1450X2000	450
	ACH200-11-1400-DL	1120	73	2700X1650X2000	3520	ACH200-MS1-C	700X1650X2000	430	ACH200-AS1-A	700X1650X2000	530
	ACH200-11-1600-DL	1250	84	2700X1650X2000	2720		700X1650X2000	430		700X1650X2000	530
	ACH200-11-1800-DL	1400	94	2700X1650X2000	3880		700X1650X2000	430		700X1650X2000	530
	ACH200-11-2000-DL	1600	105	2700X1650X2000	4000		700X1650X2000	430		700X1650X2000	530
	ACH200-11-2240-DL	1800	118	2700X1650X2000	4300		700X1650X2000	430		700X1650X2000	530
	ACH200-11-2500-DL	2000	131	2700X1650X2000	4500		700X1650X2000	430		700X1650X2000	530

Notes:

- The above dimensions and weights are just for reference, please refer to the technical agreement for specific values;
- The size of the whole machine does not include that of the fan on the top of the cabinet, so it will increase by 300mm-600mm, please see the technical agreement for details
- The front of the equipment from the wall / other equipment distance is recommended not closer than 1500mm, the back from the wall / other equipment distance is recommended not closer than 1000mm, the side from the wall / other equipment distance is recommended not closer than 800mm, the top distance from the roof is recommended to be not closer than 1000mm
- Bypass cabinet model is just for your information, actual selection should be based on working conditions.

ТОВ «ТЕХНОЕЛЕКТРО»

61166, м Харків, пр.Науки, 40, к.530а.

тел.: +38 (067) 376-84-96, (099) 184-62-14, (050) 302-90-33

Viber, WhatsApp, Telegram: +38-099-184-62-14

e-mail: info@tekhar.com

URL: www.tekhar.com

skype: alex19749